

MILWAUKEE VALVE CO
NAVY BRONZE SWING CHECK – FLANGED ENDS

1281-001

100 psi WOG

Bronze Disc – Bolted Cap
 MIL-V-17547, Type A, Class 1

DIMENSIONS – INCHES

SIZE	A	B
2	7-5/16	4-1/4
2-1/2	8-5/16	4-1/4
3	9	5-1/2
3-1/2	9	5-15/16
4	11-3/4	6-9/16
5	13-1/2	7-13/16
6	15-1/2	8-7/8
8	19-1/2	11-1/16
10	22	12

1260-004

250 psi WOG

NI-CU Disc & Seat MIL-V-17547, Type A,
 803-1385637 Class 2

Size	A	B	C
2-1/2	10	5-5/8	6-1/8
3	10-3/4	6-9/32	6-5/8
4	12-1/4	7-5/32	7-11/16
5	13-3/4	8-21/32	9-1/16
6	15-1/4	9-7/16	10-1/8
8	18-1/2	11-11/16	12-3/8
10	21-3/4	13-19/32	15
12	25-1/4	15-25/32	17-5/8

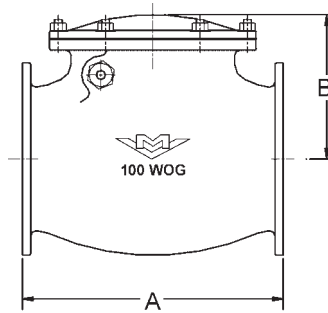
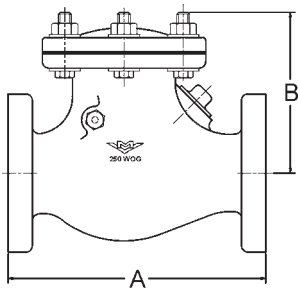

HOSE END GLOBE/ANGLE – COMMERCIAL/NAVY FLANGED

1471 / 1474

ANSI Hose Globe Valve
150 WOG

Bolted Bonnet, Gland Packed
 Renewable Composition Disc
1481 – Same as above,
 but Hose Angle Valve

Size (in)	A	B	C
1471 SERIES – COMMERCIAL			
1-1/2	6-7/8	7-3/4	6
2-1/2	9-5/16	10-1/8	7
1474 SERIES – NAVY			
1-1/2	8-3/16	8-1/16	5
2-1/2	9-5/8	10-1/8	7

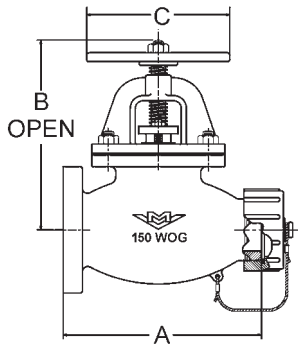

1481 / 1484

Hose Angle Valve
250 WOG

Renewable Disc 2-1/2" Bolted Bonnet
 (Specify EPR or Nitrile) (NAVSEA 803-1385712)
 1-1/2" Union Bonnet **1484** – Same as 1474,
 (NAVSEA 803-1385711) but Hose Angle Valve

Size (in)	A	B	C	D
1481 SERIES – COMMERCIAL				
1-1/2	3-1/4	7-5/16	6	3-7/16
2-1/2	4-1/8	9-1/4	7	4-3/16
1484 SERIES – NAVY				
1-1/2	2-5/8	7-1/4	5	3-3/4
2-1/2	4-1/8	8-3/4	7	4-7/8

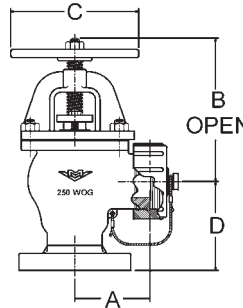

MARINE BRONZE GLOBE – SILBRAZED UNION ENDS

161 SERIES

200 psi SWP @ 425°F

400 psi WOG @ 150°F

Union Bonnet, Gland Packed
 Renewable Disc & Seat Ring
 Specify E.P.R. or Nitrile "O" Ring
 NAVSEA 803-4384536 – Type 1

DIMENSIONS – INCHES			
SIZE	A	B	C
1/4	4	4-3/8	2
3/8	4-3/8	4-11/32	2-1/2
1/2	5-1/8	5-3/16	2-3/4
3/4	5-3/4	6-1/16	3
1	6-3/8	6-7/8	3-1/2
1-1/4	7-3/8	7-11/16	4
1-1/2	8-1/4	8-3/8	4-3/4
2	9-5/8	10-7/16	5-1/4

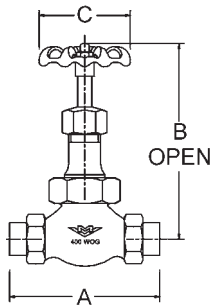

Optional Models:
 Soft Seat 161B
 Stop Check 162A
 Needle 165A

MARINE BRONZE ANGLE – SILBRAZED UNION ENDS

163 SERIES

200 psi SWP @ 425°F

400 psi WOG @ 150°F

Union Bonnet, Gland Packed
 Renewable Disc and Seat Ring
 Specify E.P.R. or Nitrile "O" Ring
 NAVSEA 803-4384536 – Type 3

DIMENSIONS – INCHES			
SIZE	A	B	C
1/4	2	4-3/8	2
3/8	2-1/4	4-11/32	2-1/2
1/2	2-7/16	5-3/16	2-3/4
3/4	2-7/8	6-1/16	3
1	3-1/4	6-7/8	3-1/2
1-1/4	3-3/4	7-11/16	4
1-1/2	4-1/16	8-3/8	4-3/4
2	4-11/16	10-7/16	5-1/4

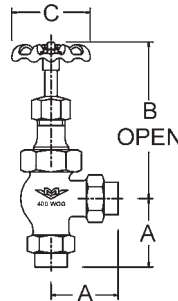

Optional Models:
 Soft Seat 163B
 Stop Check 164A
 Needle 168A

MARINE BRONZE SWING CHECK – SILBRAZED UNION ENDS

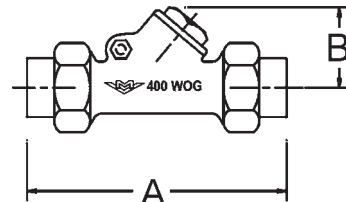

5399 SERIES

400 psi WOG @ 150°F

Regrinding NI-CU Disc
 Threaded Cap
 Specify E.P.R. or Nitrile "O" Ring
 NAVSEA 803-1385721

DIMENSIONS – INCHES		
SIZE	A	B
1/4	4-7/16	1-9/16
3/8	5-1/8	1-3/4
1/2	5-3/4	1-3/4
3/4	6-9/16	2
1	7-1/4	2-7/16
1-1/4	8-5/16	2-7/8
1-1/2	9-1/8	3-1/4
2	10-13/32	3-15/16

MARINE BRONZE GATE – SILBRAZED UNION ENDS

1146 SERIES

400 psi WOG @ 150°F

Non-rising Stem, Solid Wedge
 Threaded Bonnet, Gland Packed
 Specify E.P.R. or Nitrile "O" Ring

DIMENSIONS – INCHES			
SIZE	A	B	C
1/4	3-5/8	3-15/16	2-1/8
3/8	4-1/4	3-15/16	2-1/8
1/2	4-7/8	4-3/8	2-3/4
3/4	5-1/2	4-3/4	2-3/4
1	6-1/16	5-1/8	3
1-1/4	7-1/16	6-1/16	3-3/4
1-1/2	7-5/8	6-3/4	4
2	8-3/4	8	5

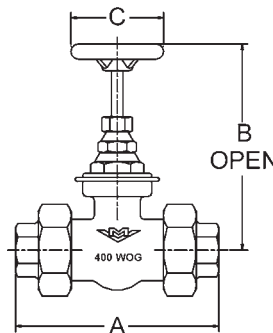

MILWAUKEE VALVE